

SECTION A-A

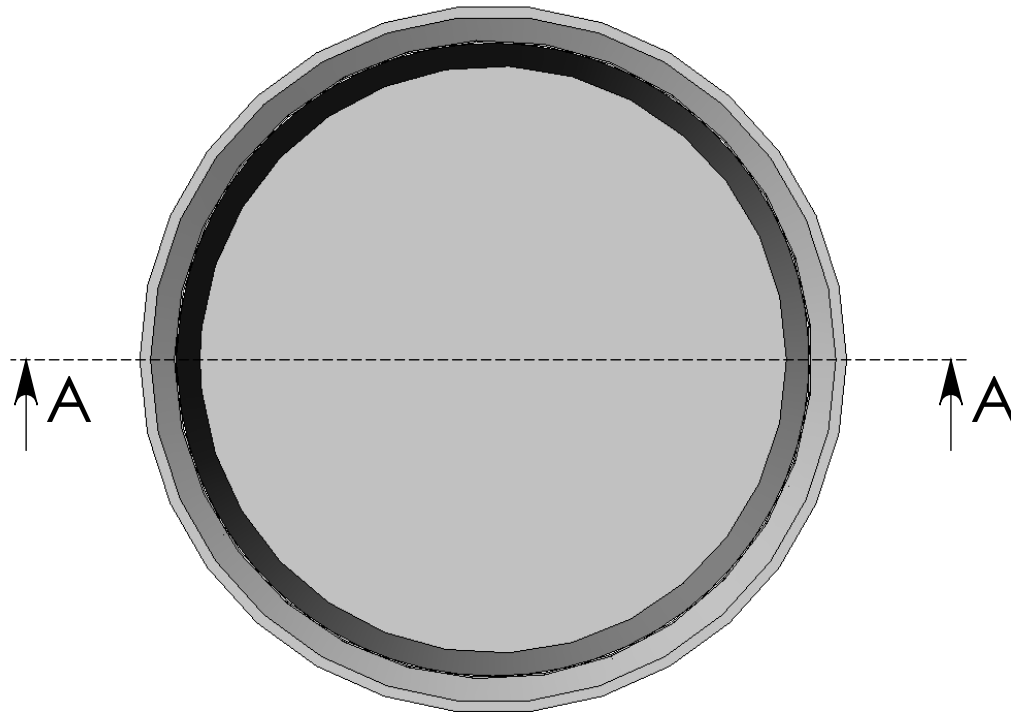
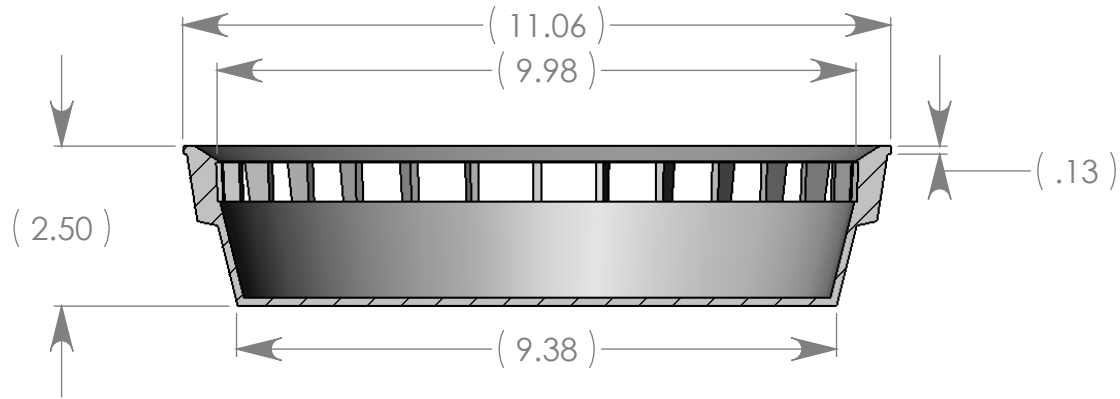

Material:	Polyethylene
Open Area:	16.6 sq. in.
Flow Rate:	21.7 GPM
ADA:	No
Wt. Class:	No
Heel:	No
Color:	Black

Use with: FSD-120-RCB

FSD-120-RST
Round Debris Trap
17Oct13