

# SECTION A-A

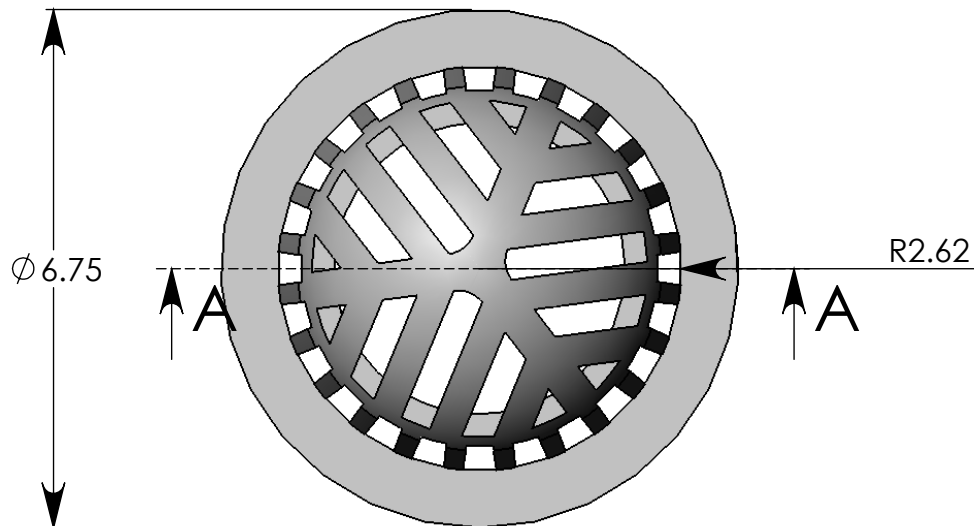
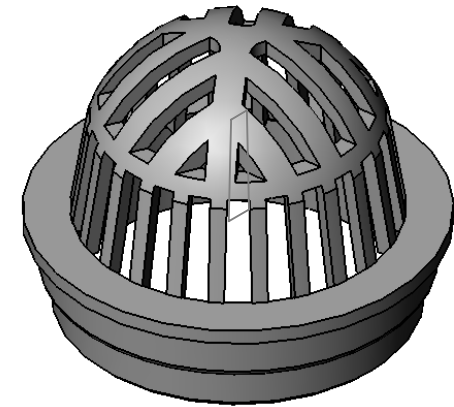
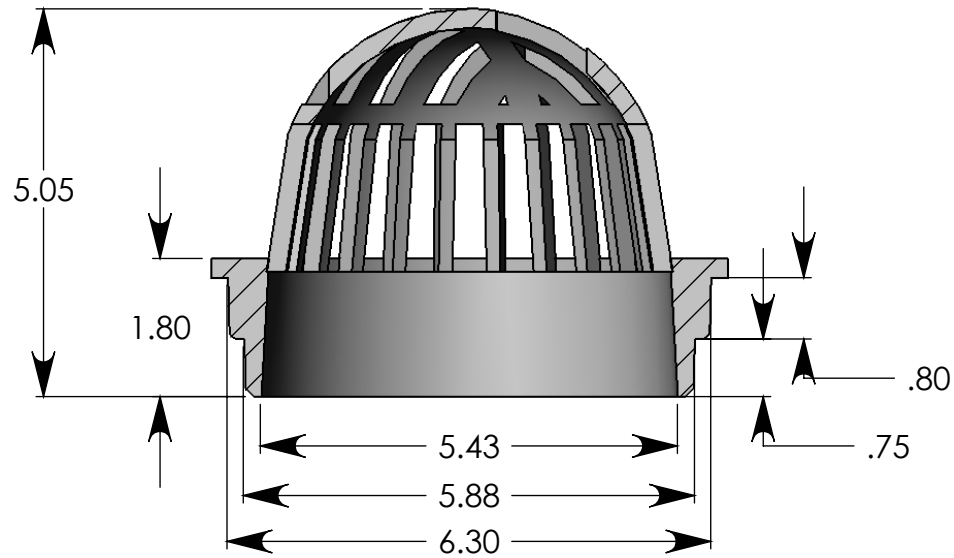

Material:	Polyethylene
Open Area:	15 sq. in.
Flow Rate:	19.6 GPM
ADA:	No
Wt. Class:	No
Heel:	No
Color:	Black

Bottom Outlet Connects to; 6" S&D Pipe, S&D Hub, Corrugated, and Sch 40

**FSD-064-A**  
Atrium Grate  
Bottom Outlet  
17Oct13